Quick Start Guide

Thank you for your purchase of LE-series.

This booklet tells you only the basic operation. For more detailed information, please refer to the instruction manual (PDF) in the utility CD attached to the product.

When you unpack the product, make sure you have all following items

<input type="checkbox"/> Line Monitor	1	
<input type="checkbox"/> Dsub 9pin Monitor Cable (LE-009M2)	1	
<input type="checkbox"/> 10pin External Input/Output Cable (LE-10ES1)	1	
<input type="checkbox"/> Micro USB Cable	1	
<input type="checkbox"/> AA-sized NiMH batteries	2	(Battery installed)
<input type="checkbox"/> Utility CD	1	
<input type="checkbox"/> Carrying Bag	1	
<input type="checkbox"/> Quick Start Guide (this booklet)	1	
<input type="checkbox"/> Warranty, Registration Card	1	

Please let us know if you find any damage to the product or accessories lacking.

It is prohibited to reprint or duplicate any part of this manual without prior permission from LINEEYE.

The content of this manual and specification of the product is subject to change without any notice.

< 3rd edition >

2019 by LINEEYE CO., LTD . All rights reserved

Safety Information

Please do not use the line monitor in the following conditions
[Description of the symbol and mark]

 **Warning:** There is a possibility of getting hurt, such as a death or a serious injury.

 **Caution:** There is a possibility of getting injured or damaging the product.

Warning

- * Do not disassemble, modify or repair the line monitor.
This may result in an injury, electric shock, and ignition.
- * Turn off the power and unplug the line monitor immediately when emanating smoke or odor.
Continuous use may result in an electric shock, burn and ignition.
- * Do not use the line monitor if there is inflammable gas.
This may result in ignition and explosion.
- * Turn off the power and unplug the line monitor immediately when liquid or foreign substance gets into the line monitor.
Continuous use may result in ignition, electric shock and malfunction.
- * Do not touch the line monitor with wet hand.
This may result in an electric shock and malfunction.
- * Do not put the line monitor in a fire or place near the heater.
This may result in an injury, ignition and explosion.
- * Do not use the batteries other than Ni-MH batteries or alkaline batteries.
This may result in generation of heat, ignition, leaking and malfunction.

Caution

- * Do not give a strong impact to the line monitor.
- * Do not place the line monitor in following conditions.
 - Not flat or vibrated place.
 - Temperature or humidity is above the specification.
 - Change the temperature rapidly. ▪ Have a direct sun or near the fire.
 - Magnetic field. Have static electricity.
- * Do not use the line monitor near the following devices.
 - Medical device, such as a heat pacemaker.
 - Automatic control devices easily affected by radio waves.
 - Devices controlled by the radio waves.

Nomenclature

[LE-170SA]

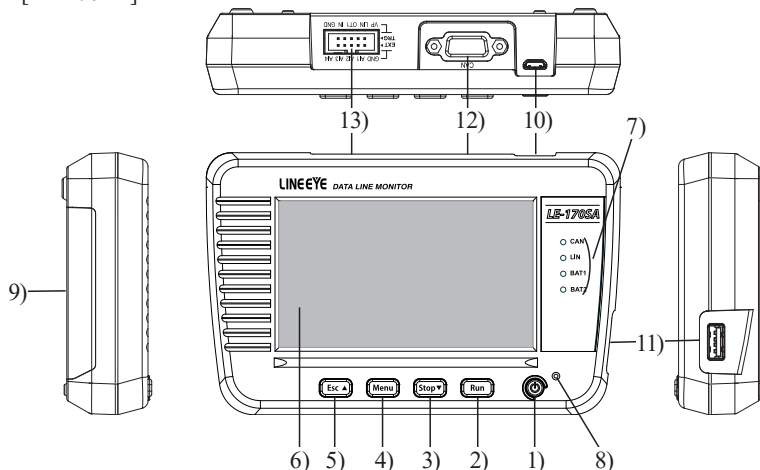

Name		Function
1)	Power Switch	Turn on / off the power
2)	[Run] key	Start monitoring / simulating
3)	[Stop] key	Stop monitoring / simulating
4)	[Menu] key	Display the top menu
5)	[Esc] key	Return to the previous display
6)	LCD	4.3 inch color LCD with touch panel
7)	Line State LED	Light in red when signal is active.
8)	Power LED	Light in green when turning on the power. Light in red; battery full charged. Blink in red: Still charging the battery.
9)	Battery Cover	Open when changing the batteries.
10)	USB Device Port	Micro-USB connector. Connect to the USB port of PC or USB battery charger.
11)	USB Host Port	Standard A USB connector. Connect to the USB flash drive.
12)	CAN port	Measurement port for CAN.
13)	LIN/External signal port	LIN port/ External signal input/output port.

Power and Battery

This line monitor drives by batteries or bus power from a USB port.

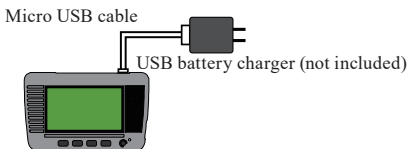
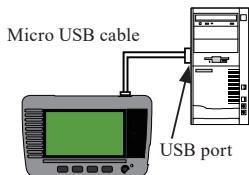

Open the battery cover and insert the attached Ni-MH batteries.

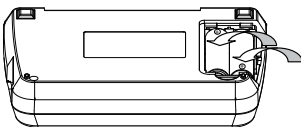
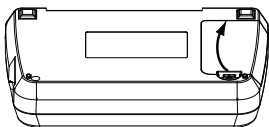

- ☒ Ni-MH batteries are used for time IC and memory IC.
To charge the Ni-MH batteries, use the battery charger for AA sized Ni-MH batteries.

LINEEYE has confirmed it works with “BQ-CC23” or “BQCC55” of Panasonic, and “TNHC-34SMC” or “TNHC-34HBC” of Toshiba.

- ☒ The line monitor is able to charge the Ni-MH batteries by appropriate settings.
Do not insert the alkali batteries to charge.



Warning (when using the line monitor with batteries)

- * Do not short the electrode of batteries.
It may cause the generation of heat, ignition, explosion, leaking and malfunction.
- * Use the batteries and battery charger which LINEEYE recommends.
If not, it may cause the generation of heat, ignition, electric shock and malfunction.
- * Do not leave the batteries near children.
- * Do not charge the Alkali batteries.
It may cause leaking, generation of heat, explosion and malfunction.
- * Do not touch directly when leaking the batteries.
It may result in serious injury, such as losing eyesight.

Operation

There are 5 keys and touch panels to control the line monitor.

Touch panels enable to select settings by soft touch or to scroll the display by swipe.



Basic operations are made by key operations. Pressing 2 keys simultaneously have the special functions.

Operations	Function
[ <p>*1 : Insert the USB flash drive into the USB host port.</p>	

*2 : To update the firmware, it is necessary to use the PC.

Initial Settings

Press [] to turn on the power.
Select the language and set date & time.

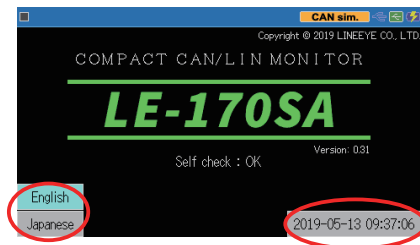

Press [Menu] key to set the initial settings.

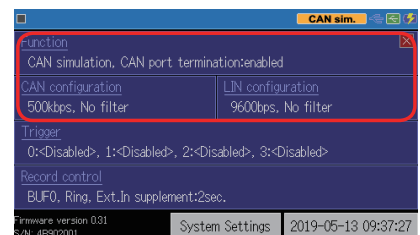

- Function : Select a function.
- CAN Configuration : Select basic communication conditions.
- LIN Configuration : Select basic communication conditions.
- Trigger : Select trigger factors and actions. Set the timer/counter for trigger function.
- Record control : The setting of how to use the capture buffer, time stamp, idle time, recording condition of the line state, Auto save function, Auto backup function, and Auto measurement condition.
- System Settings : Select a mode for power saving, battery charging and so on.

Set “Function”, “CAN Configuration” and “LIN Configuration” according to the target device and interface.

e.g.: CAN monitor

Function: Monitor

CAN Configuration: 500Kbps, sample point 75%

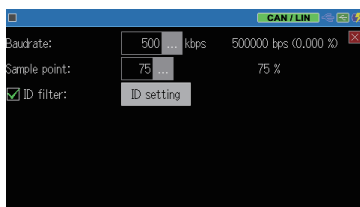
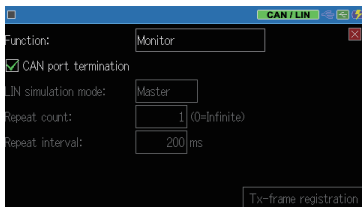

e.g.: LIN monitor

Function: Monitor

LIN Configuration: 9600bps, ID filter “None”

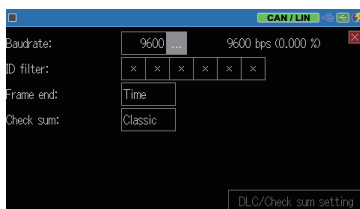
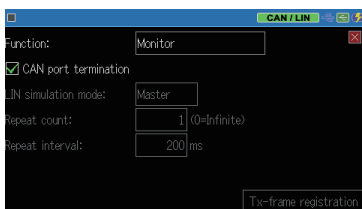

e.g.: CAN Simulation

Function: CAN Simulation

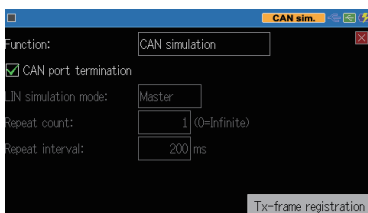

- *Set the communication condition in “CAN Configuration”.
- *Touch “Tx-frame registration” and register test data to send.

e.g.: LIN Simulation

Function: LIN Simulation



- *Master or slave simulation is possible.
- *Set the communication condition in “LIN Configuration”.
- *Touch “Tx-frame registration” and register test data to send.

Connect to the Target Device

[Connect to CAN interface]

Connect the CAN port of analyzer and target device using the attached monitor cable.

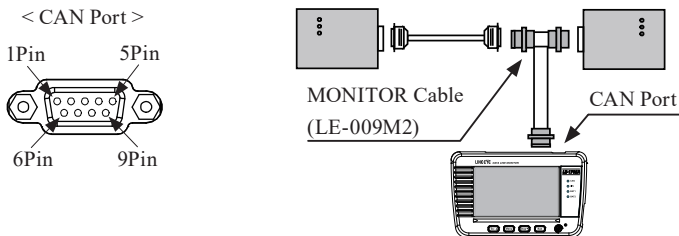

Dsub9 Pin (female)				
Pin	Signal name	Input/output ^{*1}		Description
		Monitor	Simulation	
1	-	-	-	Non-use
2	CAN	I	I/O	CAN bus signal
3	GND	-	-	Signal ground
4	-	-	-	Non-use
5	FG	-	-	Field ground
6	-	-	-	Non-use
7	CAN+	I	I/O	CAN bus power
8	-	-	-	Non-use
9	PWR	I	I	CAN bus Power ^{*2}

*1: "I" indicates "input to analyzer" and "O" indicates the "output from analyzer".

*2: LED of "BAT1" lights when using the bus power.

[Connect to LIN interface]

Connect the LIN port of analyzer and target device using the attached cable (10 pin external input/output cable) or optional cable (5-lines probe cable, "LE-5LS").

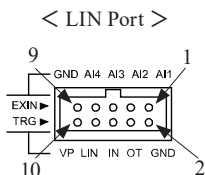

MIL box type 10pin cable ^{*1}					Cable color ^{*2}	
Signal name	Description	Pin	Input/output ^{*3}		LE-10ES1	LE-5LS
			Monitor	Simulation		
AI1	External Input1 ^{*4}	1	I	I	Brown	Brown
AI2	External Input2 ^{*4}	3	I	I	Orange	Red
AI3	External Input3 ^{*4}	5	I	I	Green	Orange
AI4	External Input4 ^{*4}	7	I	I	Purple	Yellow
GND	Signal Ground	9	-	-	White	Green
GND	Signal Ground	2	-	-	Red	
OT	External Trigger Output	4	O	O	Yellow	
IN	External Trigger Input	6	I	I	blue	
LIN	LIN bus signal	8	I	I/O	Gray	
VP	LIN bus power ^{*5}	10	I	I	Black	

* 1 : 2 lines.2.54mm pitch. Equivalent to “HIF3FC-10PA-2.54DS(71)” of HIROSE Electric. CO., LTD.

* 2 : Lead colors of attached cable (LE-10ES1) and optional cable (LE-5LS).

* 3 : “I” indicates “input to analyzer” and “O” indicates the “output from analyzer

* 4 : Analog voltage range: 0 – 52V (AD resolution 12bit)
Digital logic: VIH2.3V (Min.)/VIL 0.8V (Max.)

* 5 : LED of “BAT2” lights when using the bus power.

10pins external input/ output cable
[accessory]

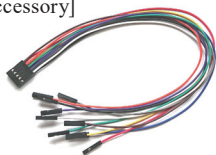

length : 300mm

5lines probe cable (LE-5LS)
[Option]

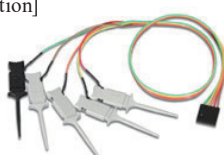

length : 360mm

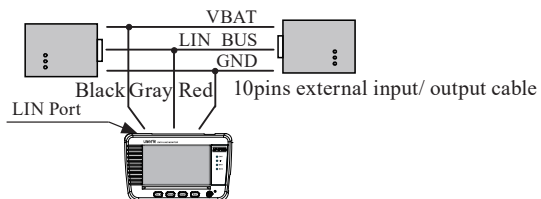

To use the analyzer near the device easily affected by radiation noise, use the shielded cable or add the ferrite core.

Measurement Start and Stop

Press [Run] to start measuring.

[Monitoring]

The line monitor displays the communication data in real time and records data in the capture buffer.

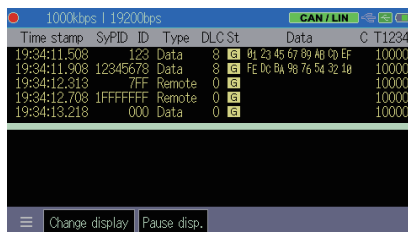

[Simulating]

It displays the monitored data and simulates data registered in the data table.

☰ Able to select the transmission data by pressing [Menu] or [...] displayed in the bottom.

☰ Register data from [Menu] → [function] → [CAN Simulation] or [LIN Simulation] → [Tx-data registration]

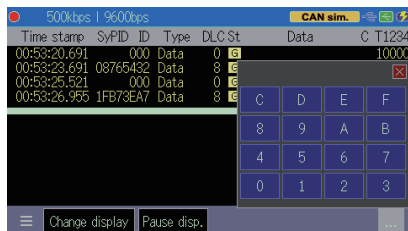

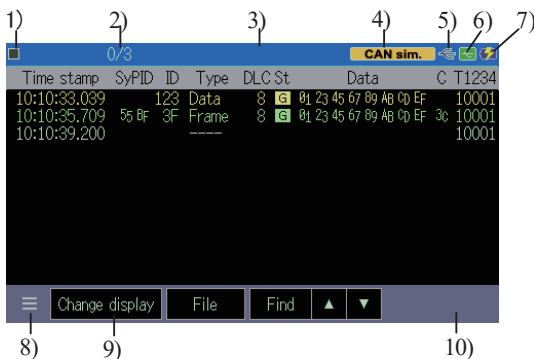

Press [Stop] to end measuring.

It is able to stop measurement automatically by setting the trigger or capture memory setting (full stop).



Each data is displayed in specific colors. CAN frame -> yellow. LIN frame -> green. External input data -> white.

1)	Measuring [], Pause []
2)	Position of data/ all data. Able to type the position to display.
3)	Other status
4)	Selected Mode [CAN/LIN]: Monitor CAN/LIN [CAN sim]: Simulate CAN [LIN master]: LIN master simulation [LIN slave]: LIN slave simulation.
5)	Status of USB device mode (Green: Connected)
6)	Status of Host port (Green: Connected) ^(*)
7)	Level of remained battery. [] indicates "bus power"
8)	Selections of other menu.
9)	Change display mode of measured data. Data display -> Analog display of external input.
10)	Other operations.



















* 1 : It becomes in red while accessing to the USB flash drive.

Swipe down the display to see the later (new) data.

Swipe up the display to see the earlier (old) data.

 Swipe quickly to scroll data fast. It is able to type any numbers in (2), to check data in different positions.

[Display]

Display	Description												
Time stamp	Time of receiving frames (H/M/S/ms)  : Matched with trigger condition)												
SyPID	Sync byte field and Protected ID field of LIN (in HEX).												
ID	Standard/ expansion ID of CAN, or LIN frame ID (in HEX).												
Type	Frame type. <table border="1"> <tr> <td>Data</td> <td>Data frame of CAN.</td> </tr> <tr> <td>Remote</td> <td>Remote frame of CAN</td> </tr> <tr> <td>Frame</td> <td>Frame of LIN.</td> </tr> <tr> <td>Illegal</td> <td>Illegal frame of LIN</td> </tr> <tr> <td></td> <td>Unknown data on the LIN bus.</td> </tr> <tr> <td>----</td> <td>Supplemental data for external input.</td> </tr> </table>	Data	Data frame of CAN.	Remote	Remote frame of CAN	Frame	Frame of LIN.	Illegal	Illegal frame of LIN		Unknown data on the LIN bus.	----	Supplemental data for external input.
Data	Data frame of CAN.												
Remote	Remote frame of CAN												
Frame	Frame of LIN.												
Illegal	Illegal frame of LIN												
	Unknown data on the LIN bus.												
----	Supplemental data for external input.												
DLC	Data length code of CAN, or DLC set in the LIN configuration (in decimal). (If frame end time is set as “time” in LIN Configuration, this will not be displayed.)												
St	Frame status. <table border="1"> <tr> <td></td> <td>Normal frame.</td> </tr> <tr> <td></td> <td>Sync Byte Field error of LIN (other than 55h).</td> </tr> <tr> <td></td> <td>Parity error of LIN.</td> </tr> <tr> <td></td> <td>Long data error of LIN.</td> </tr> <tr> <td></td> <td>Non-response data of LIN (less than 1 byte)</td> </tr> <tr> <td></td> <td>Checksum error of LIN.</td> </tr> </table>		Normal frame.		Sync Byte Field error of LIN (other than 55h).		Parity error of LIN.		Long data error of LIN.		Non-response data of LIN (less than 1 byte)		Checksum error of LIN.
	Normal frame.												
	Sync Byte Field error of LIN (other than 55h).												
	Parity error of LIN.												
	Long data error of LIN.												
	Non-response data of LIN (less than 1 byte)												
	Checksum error of LIN.												
Data	Data field (in HEX).												
C	Checksum of LIN (HEX).												
T1234	External trigger or external inputs (0: Low, 1:High)												

Other display

 06: Hex data in red color stands for the framing error.

Useful Functions

■ Trigger Function

Trigger function is for starting a specific action upon occurrence of a specific factor as a trigger.

e.g.: Stop measuring when detecting a “ID=023” CAN frame.

Press [Menu] → [Trigger]
→ Mark on “Trigger0” to
turn on the trigger
function.

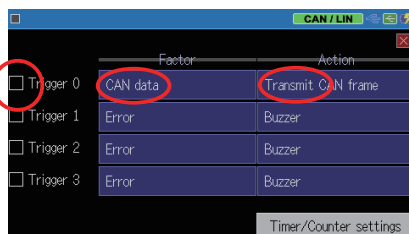

Touch “F a c t o r” of the
trigger 0 and select “CAN
data” and then touch “ID
setting” and set ID=023
in binary.

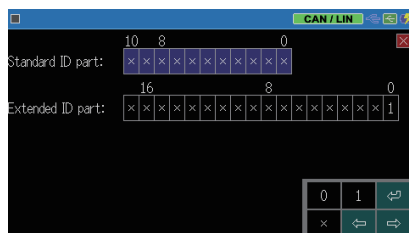
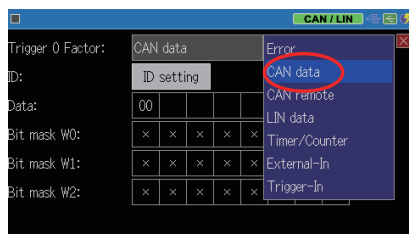

Back to the trigger setting
display by “Esc” and
touch “Action” of the
trigger 0, then select “Stop
Measurement”.

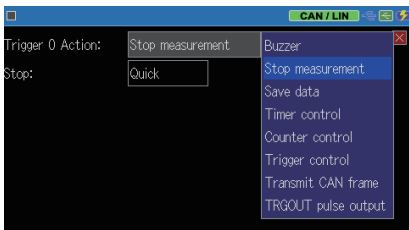

e.g.: Output a pulse to the external device when receiving a specific error.

Trigger Factor : Error

Trigger Action : TRGOUT pulse output

Output a low pulse for about 1 msec from the external trigger terminal OUT.

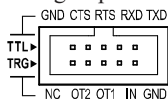

- Auto save

Measurement data is erased when turning off the power of line monitor. Auto backup function saves data of capture buffer in the USB flash drive.

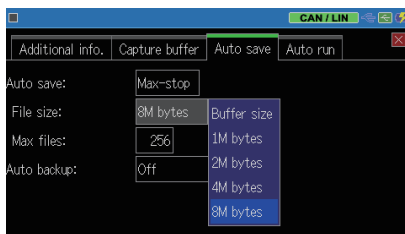

Operate [MENU], [Record control] and [Auto save] in order.

- Auto backup

When the measurement is stopped, the function automatically saves the data of the capture memory into the built-in SRAM which is backed up by the battery (for about 30K bytes of

the data which was recorded at last) or into the USB memory (all the data of capture memory to the AUTOBU.n.DAT file).

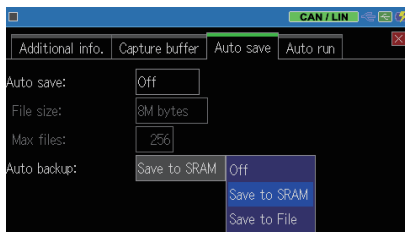

- Time specified auto RUN / STOP function

You can execute automatic measurement repeatedly of a specified period repeatedly or start measurement in conjunction with the turn-on of the power.

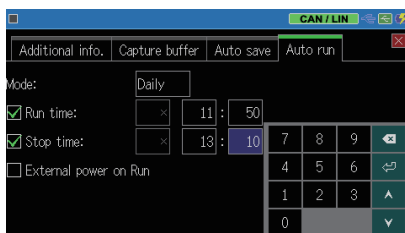

Operate [MENU], [Record control] and [Auto save] in order.

Specification

Item	LE-170SA
Interface	CAN (ISO11898) / LIN (ISO9141)
Protocol	CAN 2.0LIN (Rev. 1.1, 1.2, 1.3, 2.0, 2.1)
Communication speed(bps)	CAN: 20kbps to 1Mbps LIN: 400bps to 26kbps
Capture memory	16M bytes (about 500K data) Two-division use and automatic backup at the end of measurement are available
Monitor function	<CAN> Standard/extended format are supported, bit receiving timing can be set, filtering is available, arbitrary speed can be set.
	<LIN> Divides the frame by specified time pass or ID setting, filtering is available, arbitrary speed can be set.
Simulation function	Test data transmission (data sweep is available.)
Additional functions ^{(*)1}	Auto save function, Time specified auto RUN / STOP function, power-on RUN function.
External Trigger	Input 1, Output 1
External input	4 Measurement of 4 signals. Range: 0 to 52V. Resolution: 12 bit. Digital threshold: VIH 2.3Vmin. VIL 0.8Vmax.
Display	4.3 inch TFT color display (480x272dot)28 characters x 6-stage display.
Touch panel	Capacitive touch screen
USB2.0 device port	Micro B connector.
USB2.0 host port	Standard A connector. For USB flash drive.
Power	USB bus power 5V/500mA, two AA Ni-MH batteries, or two AA alkaline batteries
Drive time ^{(*)2}	AA sized Ni-MH batteries: about 5 hours AA sized alkaline batteries: about 2 hours
Temperature & humidity	In operation: 0 to +40°C, In storage: -10 to +50°C, 20 to 85%RH (No condensation)
Standard	CE (class A), EMC (EN61326-1:2013)
Size & weight	158mm x 100mm x 31mm, 300g(including batteries)

* 1 : Firmware Ver.1.01 or later.

* 2 : Under the normal operation.

Warranty and After Service



Warranty

- **Trouble**

Contact the distributor or LINEEYE.

- **Warranty Card**

The warranty card is attached to the product.

Confirm the content and fill out the blanks and keep it.

Warranty period: 1 year from the purchase (Does not include the one for the software.)



User registration

For the after support and the information for the product please register your product from LINEEYE website.



Repair

- Although the configuration and setting is checked and are correct but the product does not work well, contact us with the detailed information.

Model	LE-170SA
Serial number	8 digits number of Serial No.
Purchase date	Day/month/year
Situation	More detailed information is appreciated.

- **Repair within the warranty period**

We will repair it following our warranty policy. First please inform us the situation and then send it back to us with the warranty card.

- **Repair after the warranty period**

We will repair the product when the repair is possible. Check the price guide in our website and then send it back to us with the repair request document.

Memo

For any technical issues

Read "FAQ" in our website or email us. <https://www.lineeye.co.jp/html/contact.html>

LINEEYE CO., LTD.

4F., Marufuku Bldg., 39-1, Karahashi Nishihiragaki-cho, Minami-ku,
Kyoto, 601-8468, Japan

Tel : 075(693)0161 Fax:075(693)0163

URL <https://www.lineeye.co.jp> Email : info@lineeye.co.jp

Printed in Japan

M-32170SAQE/LE