

Interface Converter

## Instruction Manual

LAN ↔ RS-232C  
SI-60 / SI-60F / SI-60F-L  
LAN ↔ RS-232C x2  
SI-60X  
LAN(PoE) ↔ RS-232C  
SI-60P / SI-60FP

The CD-ROM attached to a product contains the newest English and Japanese instruction manuals in a PDF format. Please also refer to them.

## Introduction

Thank you for your purchase of SI series. To use it correctly, you are advised to read and understand this instruction manual thoroughly. Keep this together with the warranty.

### ■ ■ Notice ■ ■

- Under the copyright laws, it is prohibited to reprint or duplicate any part or the whole of this instruction manual without priority from LINEEYE CO., LTD. ("LINEEYE")
- All company and product names in this manual are trademarks or registered trademarks of their respective companies.
- The contents of this manual and specifications of the products are subject to change without notice.
- This manual has been designed and edited with great care to give you all information. If you have any questions, feel free to direct your inquiries to LINEEYE.
- LINEEYE makes no warranty or guarantee, either expressed or implied with respect to its quality, performance, merchantability, or fitness for a particular purpose. LINEEYE shall not be liable for direct, in-direct, special, incidental, or consequential damages resulting from any defect in the product. The warranty and remedies set forth above are exclusive and in lieu of all others.

Copyright © 2010-2017 LINEEYE CO., LTD. All rights reserved.

## Safety Information

Be sure to read the following

LINEEYE has developed and manufactured this product for purpose of using with electrical devices such as a computer, a personal device, a measurement device, semiconductor manufacturing equipment, a vending machine, a sequencer, display equipment and so on. LINEEYE does not manufacture this product under the purpose of using with equipment which may cause malfunction to do harm to the human body: control equipment for nuclear, aircraft equipment, life maintenance equipment, traffic signals, etc. Therefore, LINEEYE makes no guarantee with the mentioned-above use. If you use this product for the purposes mentioned above, please contact LINEEYE considering safety like Fail Safe under your responsibilities.

### Danger Level



Should the device be used without following these symbols, there is a possibility of accidents, such as a death or a serious injury, occurring.



Should the device be used without following these symbols, there is a possibility of accidents, such as an injury and material damage, occurring.

\*"Injury" indicates injury, burn, an electric shock, or the like which does not require hospitalization or the extended hospital visit. "Material damage" indicates damage related to a house, a building, furniture, apparatus, livestock or a pet.



- Do not disassemble or modify the converter and AC adapter.  
This may cause overheating, a fire, an electric shock, injury or unit malfunction.
- Stop using the converter immediately when smoke, smells, or unusual sound emanates from itself.  
Continuous use may cause a burn, fire, or electric shock.
- Keep the products dry. Keep them away from water.  
Failure to do so may cause overheating, an electric shock, or unit malfunction.
- Do not insert the metal scrap or the rubbish such as lead wires into the opening.  
Doing so may cause overheating, an electric shock, or unit malfunction.
- Never touch the converter and AC adapter with wet hands.  
Doing so may cause an electric shock.
- Remove the dust on the AC adapter periodically to prevent the heat and ignition.

- Never use the converter in the place where an inflammable gas leaks.  
Doing so may cause ignition.
- Do not conduct the installation or wiring work when power is applied.  
Doing so may cause an electric shock or unit malfunction.
- Do not use the damaged cables.  
Doing so may cause fire by overheating.
- Use the included AC adapter or ones specified by LINEEYE.  
Failure to do so may cause overheating, fire, an electric shock, or injury.
- Never touch the converters and cables while thunderbolts are occurring.
- Do not connect the power cord to an outlet that has an illegal number of connections.  
Doing so may cause fire by overheating.



- Do not install the converter in the unstable or vibrating place.  
Doing so may cause unit malfunction or injury.
- Do not install the converter in any temperature and humid places, or any places which has the extreme temperature change.  
Doing so may cause unit malfunction.
- Do not install the converter in any places exposed to direct sunlight.  
Doing so may cause a burn or unit malfunction by overheating.
- Be sure not to short-circuit the pins on the connector.  
Doing so may cause unit malfunction or injury.
- Use the included AC adapter with the converter only.  
Failure to do so may cause fire or injury by overheating.
- Be sure to hold the converter when you disconnect the AC adapter from it.  
Failure to do so may cause fire or an electric shock by damaging a cord.
- Please do not damage the power cable by pulling, stamping, or tearing.  
This may result in a injury, an electric shock, fire, explosion and or a breakdown due to overheating.
- Do not place the cord of the AC adapter near heating equipment.  
Doing so may cause fire or an electric shock by melting the cord's cover.

## ■■ Contents ■■

Chapter 1 Before Using The Product 5	8-3. Install COM Port Redirector.....28
1-1. Unpacking and Product Composition.....5	8-4. COM Port Redirector.....29
1-2. How to read this instruction manual .....5	Chapter 9 Documents..... 30
1-3. Overview .....6	9-1. Built in XPort .....30
1-4. Specifications .....6	9-2. Factory setting.....30
Chapter 2 SI-60F Usage..... 7	9-3. How to apply the factory setting32
2-1. SI-60F Overview and Features ..7	9-4. General-purpose I/O pins.....34
2-2. SI-60F Panel Explanation .....8	9-5. LAN Connector Specification 34
2-3. SI-60F Cable Connection.....9	9-6. Installation Method .....35
2-4. SI-60F Power Source .....9	9-7. Ordering information .....37
Chapter 3 SI-60 Usage ..... 10	9-8. Option.....37
3-1. SI-60 Overview and Features ..10	Chapter 10 Warranty and After-Sales Service.... 38
3-2. SI-60 Panel Explanation ..... 11	10-1. Troubleshooting ..... 38
3-3. SI-60 Cable Connection.....12	10-2. Warranty and Repair .....40
3-4. SI-60 Power Source .....12	10-3. After-Sales Service.....40
Chapter 4 SI-60X Usage ..... 13	
4-1. SI-60X Overview and Features13	
4-2. SI-60X Panel Explanation ..... 14	
4-3. SI-60X Cable Connection.....15	
4-4. SI-60X Power Source ..... 15	
Chapter 5 Basic Configuration..... 16	
5-1. Connect to the LAN network...16	
5-2. Basic configuration ..... 16	
5-3. Default IP address ..... 17	
5-4. Usage of DeviceInstaller.....17	
5-5. Confirm IP address.....18	
5-6. Assign IP address ..... 19	
Chapter 6 Configuration Using Web Manager ..... 20	
6-1. Web Manager Usage .....20	
6-2. Communication conditions of serial port.....22	
6-3. Set up LAN connection mode...22	
6-4. Other Setting .....23	
Chapter 7 Setup Example..... 24	
7-1. Server mode usage .....24	
7-2. Client Mode Usage .....25	
7-3. Using two units of converter...26	
Chapter 8 COM Port Redirector ..... 28	
8-1. About Virtual COM Port .....28	
8-2. Basic Setting.....28	

# Chapter 1 Before Using The Product

---

## 1-1. Unpacking and Product Composition

---

Make sure of the following when unpacking the product.

Please let your LINEEYE distributor or LINEEYE know if you find any damage to the product caused by transportation, or if there are accessories lacking.

SI-60, SI-60F, SI-60F-L, SI-60X

<input type="checkbox"/> Converter	: 1
<input type="checkbox"/> AC Adapter	: 1 <sup>*1, *3</sup>
<input type="checkbox"/> Utility CD-ROM	: 1 <sup>*2, *3</sup>
<input type="checkbox"/> Instruction Manual	: 1 <sup>*3</sup>
<input type="checkbox"/> Warranty	: 1

SI-60P, SI-60FP

<input type="checkbox"/> Converter	: 1
<input type="checkbox"/> Utility CD-ROM	: 1 <sup>*2</sup>
<input type="checkbox"/> Instruction Manual	: 1
<input type="checkbox"/> Warranty	: 1

\*1 For the foreign market (not Japan), the model (with -E) includes an AC adapter of AC100V-240V (6A181WP09). For Japanese market the model (without -E) includes an AC adapter of AC100V (VFN-650B)..

\*2 This CD-ROM includes manuals and tools for setup. Please read the README.txt for further details.

\*3 -NS models do not have these items.

## 1-2. How to read this instruction manual

---

First, please read instruction about power supply and how to connect the device at the chapter of the model. Then read chapter 5, chapter 6, and chapter 8 for the details of the configuration and IP address setting.

### ● Description of I/O pins on the XPort

The description of I/O pins of XPort at configuration differs depending on the version of the WEB manager. And the version of the WEB manager also differs depending on the version of the XPort. Please refer to the following information to apprehend the meaning of the description at configuration.

For more information about this matter, please refer to the Chapter 9-1.

Web Manager Ver1.8.0.1 or before	: CP0, CP1, CP2
Web Manager Ver1.9.0.1 or later	: CP1, CP2, CP3. (Examples in this manual use this description)

### ● SI-60F-L

SI-60F-L is the model which has a different type of body but has same function as that of SI-60F. When you need information about SI-60F, please see the reference about SI-60F. Please note that SI-60F-L is for wall mounting, thus optional L Bracket and DIN plate cannot be used for SI-60F-L.

### ● SI-60FP and SI-60P

SI-60FP and SI-60P are the model which has the same function as that of SI-60F and SI-60 and also support PoE (Power over Ethernet: IEEE 802.3af/at) power supply. When you need information about SI-60FP or SI-60P, please see the reference about SI-60F and SI-60 because the functions other than PoE are the same as those of SI-60F and SI-60.

### 1-3. Overview

SI-60F/SI-60X/SI-60 are communication converters to convert asynchronous communication of serial interface to TCP/IP communications on Ethernet LAN. SI-60/SI-60F convert one port of RS-232C and SI-60X converts two ports of RS-232C. These converters have built-in Lantronix XPort at the LAN interface part. You can control the device which has a serial port from a PC on the network by socket communication. By using COM port redirector, which is included in the CD-ROM, you can use it like com port communication. It is also possible to extend the serial line without PC by connecting the two devices by LAN.

### 1-4. Specifications

		SI-60X	SI-60FP	SI-60F/(-L)	SI-60P	SI-60	
S e r i a l	Interface	RS-232C x2		RS-232C			
		Dsub9 Pin (Male) #4-40 UNC (inch screw)			Dsub25 Pin (Female) M2.6 mm Screw		
		DTE fixed			DTE/DCE Switchable		
	Synchronous Method	Asynchronous					
	Baud Rate (bps)	300/600/1200/2400/4800/9600/19200/38400/57600/115200/230400/ 460800 <sup>*1</sup> /921600 <sup>*1</sup>					
	Data Frame Structure	Data (7 or 8) + Parity (Even, Odd or None) + Stop (1 or 2)					
	Flow Control	Xon/off RTS/CTS					
	LED Display	SD,RD			SD,RD,RS,CS,(6-20)		
	Surge Protection	15KV ESD					
	L A N	Interface	Ethernet IEEE802.3 RJ-45 connector 10BASE-T/100BASE-TX				
Protocol		ARP, TCP/IP, UDP/IP, ICMP, SNMP, TFTP, Telnet, DHCP, BOOTP, HTTP, AutoIP					
LED Display		10BASE-T <sup>*2</sup> , 100BASE-TX, <sup>*2</sup> Activity, Link, Full/Half duplex <sup>*2</sup>					
Transformer Insulation		1500V					
Management	Web manager, Telnet connection, Serial port connection						
Power Supply	DC5 to 30V		DC5 to 25V	DC5 to 30V	DC5 to 12V		
Power Consumption	1.5W / 2.8VA <sup>*3</sup>	1.5W(DC-IN) 2W(PoE)	1.5W / 2.8VA <sup>*3</sup>	1.5W(DC-IN) 2W(PoE)	3W / 4.2VA <sup>*3</sup>		
Operating Temperature, Humidity	-10 to +50°C, 10 to 95%RH	-20 to +50°C, 10 to 95%RH	-10 to +50°C, 10 to 95%RH	-20 to +50°C, 10 to 95%RH	-10 to +50°C <sup>*4</sup> , 10 to 95%RH		
Storage Temperature, Humidity	-20 to +80°C, 10 to 95%RH						
External Dimension (W x D x H)	78×85× 24mm	58×88× 24mm	82×88× 24mm <sup>*5</sup>	65×95×24mm			
Weight	220g	170g	170g	200g			

\*1 SI-60 cannot be used at 460.8Kbps and 921.6Kbps.

\*2 On SI-60F and SI-60, you can distinguish 10BASE-R or 100BASE-TX and Half-duplex or Full-duplex by seeing the lighting color of the LED.

\*3 Act as a Class 1 receive device of Power over Ethernet: IEEE802.3af/at

\*4 In the case of using the attached AC adapter (AC100V).

\*5 When the power supply voltage, which is supplied from the connector (SI-60), is DC10V or higher the operating temperature is limited up to +40 degree.

\*6 Includes the mount part.

# Chapter 2 SI-60F Usage

## 2-1. SI-60F Overview and Features

SI-60F converts asynchronous communications of RS-232C interface to TCP/IP or UDP/IP communications on Ethernet LAN. Having XPort as its LAN interface, SI-60F offers highly-reliable communication.

\* For further detail about configuration and IP address setting, please refer to chapter 5, 6, and 8.

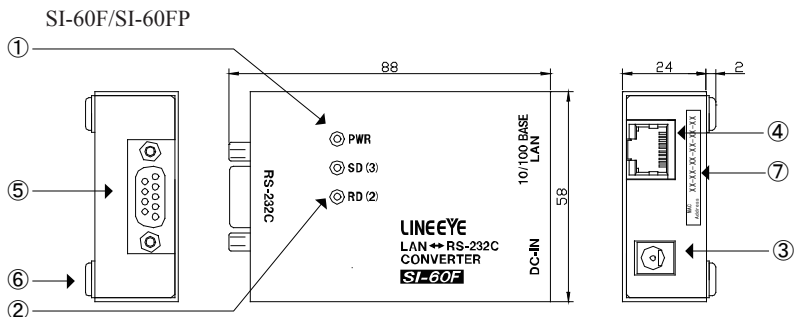

\* The appearance of SI-60FP differs at model name and description on the LAN connector.

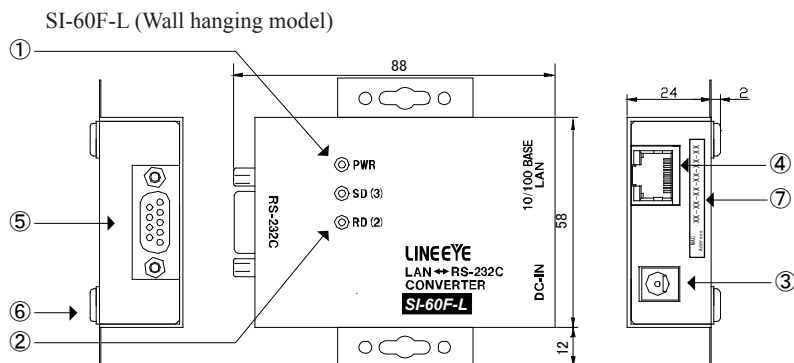

The functions of SI-60F and SI-60F-L are the same. For the detailed dimensions of SI-60F-L, please refer to “To attach to the wall (SI-60F-L)” of 9-6. Installation Method.



## 2-2. SI-60F Panel Explanation

No.	Name	Explanation	Note
1	Power LED	It lights when the SI-60F is powered.	
2	Data Status LED	It lights when SD/RD signal of RS-232C is active. The numbers in the parentheses indicate the pins of RS-232C.	
3	AC Adapter Jack	A socket to connect to an AC adapter.	→ [ 2-4. ]
4	Ethernet Connector	Ethernet IEEE802.3 RJ-45 connector 10Base-T/100Base-TX auto-detection available.	→ [ 9-5. ]
5	RS-232C Connector	Dsub9 pin (male) Screw: #4-40 UNC(inch screw)	
6	Rubber foot	Rubber foot to place SI-60F horizontally	→ [ 9-6. ]
7	MAC address seal	The hardware address (MAC address) of the unit.	

### ● RS-232C Connector Pin Assignment

Pin No.	Name	I/O Direction *1	Description
1	CD	-	non-connected
2	RD	In	Reception Data
3	SD	Out	Transmission Data
4	ER	In	Internal connection to 6 pin *2
5	GND	-	Signal Grand
6	DR	In	Internal connection to 4 pin *2
7	RS	Out	Transmission Request
8	CS	In	Transmission Permit
9	CI	-	non-connected

\*1 "Out" means a direction to output signals from the converter.

"In" means a direction to input signals to the converter.

\*2 Inputs the negated signals to the CP1 terminal on a built-in XPort.

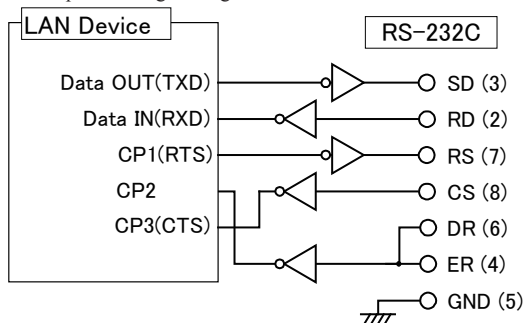

The LAN device for SI-60F is XPort and the one for SI-60FP is xPico.

\* Descriptions in ( ) is for SI-60FP

\* The numbers in ( ) on RS-232C side are the pin numbers of DSUB connector.

## 2-3. SI-60F Cable Connection

---

### LAN

Connect to the LAN connector of SI-60F with a LAN cable of category 5e or more.  
→[ 5-1.Connect to the LAN network]

### RS-232C

Connect by the proper RS-232C cable which fits the shape of the RS-232C connector on the target devices. Then, make sure of the input/output specification of signal pins.  
e.g.1: Connecting the serial port (Dsub9 pin - male) of SI-60F to the device (Dsub25 pin, female) of DCE specification.

→ Use straight connection cable such as SI-RS259(SI-RS259 cable is an optional cable.) to connect.

e.g.2: Connecting the serial port (Dsub9 pin - male) of SI-60F to the device (DSUB9pin, male) of DTE specification.(male)

→ Use cross connection cable which both ends with DSUB9pin(female) to connect.

e.g.3: Connecting the AUX port (Mini DIN8 pin, female) of analyzers, (LE-8200/3500/2500/7200/3200/2200/1200) to SI-60F.

→ Use LE2-8V cable to connect.(LE2-8V cable is an optional cable.)

## 2-4. SI-60F Power Source

---

There are two ways to supply power to SI-60F.

### ● Supply by AC

1. Connect the plug of the AC adapter to the DC jack of SI-60F.
2. Plug the AC adapter to an outlet to supply power.  
Please use appropriate AC adapter which complies with the power specification and safety standards of the country in which you use SI-60F.

Model	Power specification	Safety standards
VFN-650B	AC 100V ± 15%, 50/60 Hz	PSE
6A-181WP09	AC 90 - 264 V, 50/60 Hz	PSE/UL/CUL/GS/CCC/CE

### ● Supply by DC

1. Prepare external DC source of 5 - 25V<sup>\*1</sup>, 1.5W<sup>\*2</sup> or more.  
\*1: SI-60FP supports up to 30V.  
\*2: The current consumption is as follows: 250mA (when DC is 5V), 100mA (when DC is 12V), 50mA (when DC is 25V)
2. Connect the DC-IN of SI-60F with the output terminal of the external source by using SIH-2PG (an option sold separately). It does not matter + or - because the DC-IN is non-polar.<sup>\*3</sup>  
\*3: The size of the DC plug which fits in the DC-IN is as follows: Outer diameter is 5.5mm, inner diameter is 2.1mm, length of top of the plug is 9.5mm.

### ● When powered by a PoE supported hab (SI-60FP).

Power the unit by using LAN cable and a hub which supports PoE (IEEE 802.3af or IEEE 802.3at). By the hub SI-60FP is regarded as a PD (Powered device) of Class 1 (0.44 - 3.84W).

## Chapter 3 SI-60 Usage

### 3-1. SI-60 Overview and Features

SI-60 converts asynchronous communications of RS-232C interface to TCP/IP or UDP/IP communications on Ethernet LAN. Having XPort as its LAN interface, SI-60 offers highly-reliable communication.

- \* For further detail about configuration and IP address setting, please refer to chapter 5, 6, and 8.

SI-60 adopts DSUB25 pin connector and you can switch it to DTE or DTC, which allows you to connect any device to RS-232C interface of SI-60.

The following chart shows the internal structure of SI-60.

When switched to DTE

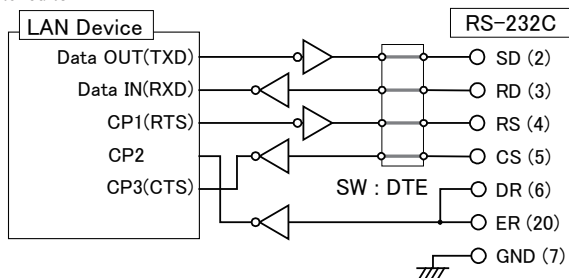

When switched to DCE

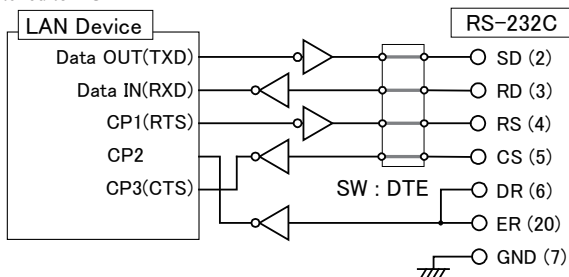

The LAN device for SI-60 is XPort and the one for SI-60P is xPico.

\* Descriptions in ( ) is for SI-60P

\* The numbers in ( ) on RS-232C side are the pin numbers of DSUB connector.

➔ [ 3-2. SI-60 Panel Explanation ]

## 3-2. SI-60 Panel Explanation

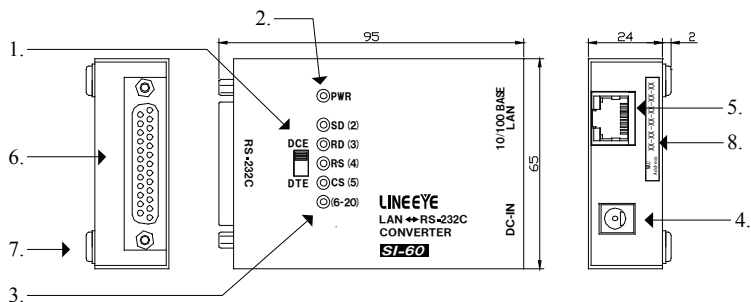

\* The appearance of SI-60P differs at model name and description on the LAN connector.

No.	Name	Explanation	Note
1	DTE/DCE Switch	Switcher to change the specification of RS-232C connector of SI-60 to DTE or DCE.	➔ [ 3-1. ]
2	Power LED	It lights when the SI-60 is powered.	
3	Data Status LED	It lights when each signal of RS-232C is active. The numbers in the parentheses indicate the pins of RS-232C.	
4	AC Adapter Jack	A socket to connect to an AC adapter. (Non-polar)	➔ [ 3-4. ]
5	Ethernet Connector	Ethernet IEEE802.3 RJ-45 connector 10Base-T/100Base-TX auto-detection available.	➔ [ 9-5. ]
6	RS-232C Connector	Dsub25 pin (Female) M2.6 mm Screw	
7	Rubber foot	Rubber foot to place SI-60 horizontally	➔ [ 9-6. ]
8	MAC address seal	The hardware address (MAC address) of the unit.	

### ● RS-232C Connector Pin Assignment

Pin No. *1	Name	I/O Direction *2		Description
		DTE	DCE	
1	FG	-		Frame Grand
2	SD	Out	In	Transmission Data
3	RD	In	Out	Reception Data
4	RS	Out	In	Transmission Request
5	CS	In	Out	Transmission Permit
6	DR	In	In	Internal connection to 20 pin *3
7	GND	-	-	Signal Grand
9	+DC IN	-	-	External power supply input *4
20	ER	In	In	Internal connection to 6 pin *3

\*1 Pins not mentioned in this table indicate the non-connected terminals.

\*2 "Out" means a direction to output signals from the converter.

"In" means a direction to input signals to the converter.

\*3 Inputs the negated signals to the CPI terminal on a built-in XPort.

\*4 ➔ [ 3-4. SI-60 Power Source ]

### 3-3. SI-60 Cable Connection

---

#### LAN

Connect to the LAN connector of SI-60 with a LAN cable of category 5e or more.

➔ [ 5-1. Connection to the Network ]

#### RS-232C

Connect with the proper RS-232C cable which fits the shape of the RS-232C connector on the target devices. Then, make sure of the input/output specification of signal pins and connection of the RS-232C cable. Set DTE/DCE switch.

e.g.1: Use straight connection cable to connect the device which has DCE specifications.

➔ Set DTE/DCE switch to DTE.

e.g.2: Use SI-RS259 cable to connect the PC(DTE).

➔ Set DTE/DCE switch to DCE.

e.g.3: Use LE2-8V cable to connect the AUX port (Mini DIN8 pin, female) of analyzers, (LE-8200/3500/2500/7200/3200/2200/1200) to SI-60.

➔ Set DTE/DCE switch to DTE.

### 3-4. SI-60 Power Source

---

There are two ways to supply power to SI-60.

#### ● Supply by AC

1. Connect the plug of the AC adapter to the DC jack (DC-IN) of SI-60.
2. Plug the AC adapter to an AC outlet to supply power.

Please use appropriate AC adapter which complies with the power specification and safety standards of the country in which you use SI-60.

Model	Power specification	Safety standards
VFN-650B	AC 100V ± 15%, 50/60 Hz	PSE
6A-181WP09	AC 90 - 264 V, 50/60 Hz	PSE/UL/CUL/GS/CCC/CE

\* Power consumption when using an AC adapter “VFN-650B” is about 4.2VA (for SI-60).

#### ● Supply by RS-232C connector

1. Prepare DC source of 5 - 12V (DC 5 - 9V is recommended), 4W or more. Note: Current consumption of SI-60 is up to 250mA regardless of supply voltage. External source of lower voltage is recommended. Because the more voltage is, the more power consumption and heat tend to be.
2. Process a RS-232C cable and connect the 9th pin of the RS-232C connector with the plus pole of the external source and connect the 7th pin with the minus pole of the source.

#### ● When powered by a PoE supported hub (SI-60P).

Power the unit by using LAN cable and a hub which supports PoE (IEEE 802.3af or IEEE 802.3at). By the hub SI-60P is regarded as a PD (Powered device) of Class 1 (0.44 - 3.84W).

# Chapter 4 SI-60X Usage

## 4-1. SI-60X Overview and Features

SI-60X converts two ports of asynchronous communications of RS-232C interface to TCP/IP or UDP/IP communications on Ethernet LAN. Having WiPortNR as its LAN interface, SI-60X offers access to two RS-232C ports through two local ports of IP addresses set on SI-60X. SO-60X has a switch to initialize it to factory default setting (INIT SW), which helps when you cannot find out the IP address etc. SI-60X is suitable when two devices of RS-232C interface are nearby and you need to convert the communication data of the devices into LAN.

\* For further detail about configuration and IP address setting, please refer to chapter 5, 6, and 8.

The following chart shows the internal structure of SI-60X.

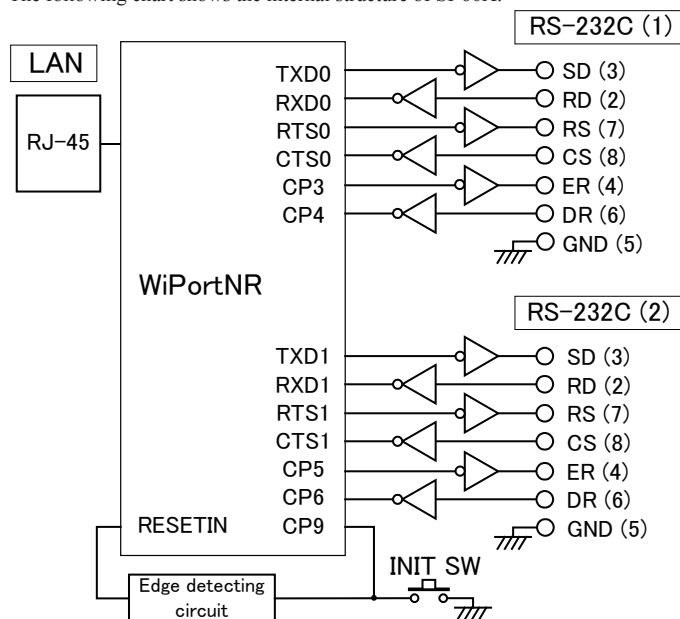

## 4-2. SI-60X Panel Explanation

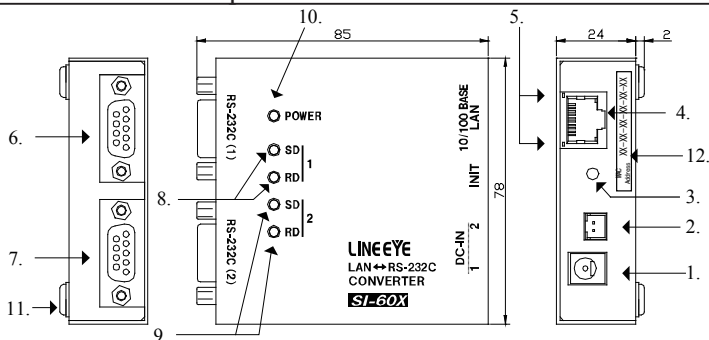

No.	Name	Explanation	Note
1	DC-IN 1	A socket to connect to an AC adapter.	→ [ 4-4. ]
2	DC-IN 2	XH connector for DC supply (non-polar) Inside of SI-60X , DC-IN 2 is connected in parallel with DC-IN 1.	→ [ 4-4. ]
3	INIT SW	A switch to initialize SI-60X	
4	Ethernet Connector	Ethernet IEEE802.3 RJ-45 connector 10Base-T/100Base-TX auto-detection available.	→ [ 4-5. ]
5	LAN LED	The LED on the left lights when linked. The LED on the right lights when communicating.	
6	RS-232C (1) Connector	RS-232C Port 1 *2Dsub9 pin (male) Screw: #4-40 UNC (inch screw)	
7	RS-232C (2) Connector	RS-232C Port 2 *2Dsub9 pin (male) Screw: #4-40 UNC (inch screw)	
8	Data Status LED (1)	It lights when SD/RD signal of RS-232C port 1 is active.	
9	Data Status LED (2)	It lights when SD/RD signal of RS-232C port 2 is active.	
10	Power LED	It lights when the SI-60X is powered.	
11	Rubber foot	Rubber foot to place SI-60X horizontally	→ [ 9-6. ]
12	MAC address seal	The hardware address (MAC address) of the unit.	

### ● RS-232C Connector Pin Assignment

Pin No.	Name	I/O Direction *1	Description
1	CD	-	non-connected
2	RD	In	Reception Data
3	SD	Out	Transmission Data
4	ER	In	Internal connection to 6 pin *2
5	GND	-	Signal Grand
6	DR	In	Internal connection to 4 pin *2
7	RS	Out	Transmission Request
8	CS	In	Transmission Permit
9	CI	-	non-connected

\*1. "Out" means "from SI-60X" and "In" means "to SI-60X".

## 4-3. SI-60X Cable Connection

### LAN

Connect to the LAN connector of SI-60X with a LAN cable of category 5 or more.

➔ [ 5-1. Connection to the Network ]

### RS-232C

SI-60X has two Dsub9 pin(male) of DTE specification.

Connect by a proper RS-232C cable which fits to the RS-232C connector of the target device. Please make sure of the input/output specification of signal pins.

e.g.1: To connect the serial port (Dsub9 pin - male) of SI-60X with a device (Dsub25 pin, female) of DCE specification, use straight connection cable such as SI-RS259. (SI-RS259 cable is an optional cable.)

➔ Set DTE/DCE switch to DTE.

e.g.2: To connect the serial port (Dsub9 pin - male) of SI-60X with a device (DSUB9pin, male) of DTE specification, use cross connection cable which has ends of DSUB9pin (female).

## 4-4. SI-60X Power Source

There are two ways to supply power to SI-60.

### ● Supply by AC

1. Connect the plug of the AC adapter to the DC-IN1 jack of SI-60X.
2. Plug the AC adapter to an AC outlet to supply power.

Please use appropriate AC adapter which complies with the power specification and safety standards of the country in which you use SI-60X.

Model	Power specification	Safety standards
VFN-650B	AC 100V ± 15%, 50/60 Hz	PSE
6A-181WP09	AC 90 - 264 V, 50/60 Hz	PSE/UL/CUL/GS/CCC/CE

### ● Power supply by branch cable

When you place two SI-60Xs nearby, you can supply power to SI-60X with an AC adapter by using an optional power branch cable (LAH-2XH). To do this, please use 6A-181WP09 (AC adapter) because it has ample output capacity.

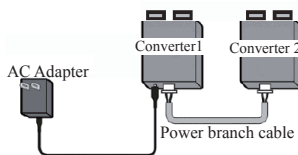

### ● Supply by DC

1. Prepare external DC source of 5 - 30V, 1.5W or more.
  - \* Current consumption of SI-60X is as follows: 250mA (when DC is 5V), 100mA (when DC is 12V), 45mA (when DC is 30V)
2. Connect the DC-IN2 of SI-60X with the output terminal of the external source by using optional power cable (such as LAH-15XH). It does not matter + or - because the DC-IN2 is non-polar.
  - \* A connector of the cable which fits in the DC-IN2 is as follows: XHP-2 (JST Mfg. Co., Ltd.) and SXH-001T-P0.6 (crimp contact, JST Mfg. Co., Ltd.). Please use appropriate crimp tools when you make a cable by yourself.



# Chapter 5 Basic Configuration

## 5-1. Connect to the LAN network

Connect LAN connector of converter to the HUB/PC using LAN cable.

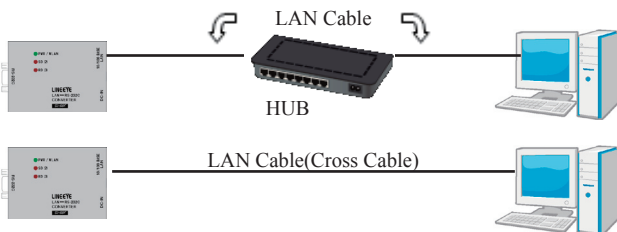

- \* This converter does not have AutoMDI/MDI-X function to find the LAN port. To connect LAN port of PC directly, use the LAN cable with cross connection.
- \* Try to use a short LAN cable when concerning the noise.

## 5-2. Basic configuration

Configuration can be set from following procedure.

- Set through network using Web browser  
Input the IP address in the Web browser of the PC, and set from the Web manager.  
→ Refer to "Chapter 6".
- Use set-up mode  
Connect the converter by serial/telnet connection, and then open the set-up mode. (For serial connection, input the special command after turning on the power to enter into the set-up mode. Use "RS-232C port 1" for SI-60X.)  
→ Refer to [ XPort User Guide (XPort\_UG.pdf) ] and [ WiPort NR User Guide (WiPort-NR\_UG.pdf) ] in the CD-ROM.

If entering the incorrect IP address, it may affect the whole network. To use it properly, consult with your network manager. Please write down the important configuration in case of resetting.

- IP Address .....[ . . . ]
- Subnet Mask.....[ . . . ]
- Default Gateway.....[ . . . ]

## 5-3. Default IP address

---

As a factory setting, DHCP client mode and AutoIP function automatically set IP address.

- \* When the IP address is 0.0.0.0 (factory setting), those functions are valid. When IP address is 0.0.1.0, only DHCP client function is valid.

### When having DHCP server in the network

IP address is automatically set from the DHCP server when turning on the power of device.

### When not having DHCP server in the network

One of the IP addresses of "169.254.1.0" to "169.254.254.255" is automatically set by the AutoIP function when turning on the power of device.

➔ Refer to "Chapter 5.4"

## 5-4. Usage of DeviceInstaller

---

Install the DeviceInstaller of Lantronix for setting the IP address.

Preparation: Log to the PC as administrator. If you had already installed the previous version of DeviceInstaller, uninstall it.

- \* If you would like to use the converter with XPort firmware Ver.1.8, used the previous version of DeviceInstaller. The latest XPort firmware is displayed as "Unknown:x5" or "Unknown:x9".

1 Double click on "setup\_di\_x86x64cd\_4.4.0.4.exe" in the "/lantronix/DeviceInstaller/ver4.4.x.x" folder. If you find the latest version in the CD-ROM, use the latest version.

2 Install it following the wizard.

- \* OS for DeviceInstaller(v4.4.x.x): Windows x86: 7, 8/8.1, 10  
Windows x64: 7, 8/8.1, 10, Server 2008/2012

- \* If the PC is connected to the Internet, ".NET Framework" is automatically installed. Refer to the "Release.txt" file in the CD-ROM for information of ".NET Framework" version.

3. Click [No] if following dialog is appeared.

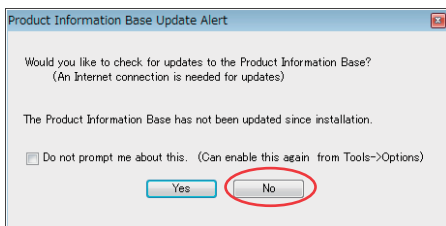

## 5-5. Confirm IP address

---

1. Connect the converter to the network and turn on the power.
2. Open the DeviceInstaller from Start menu.
3. A device which has a LAN device of Lantronix is displayed on the main window

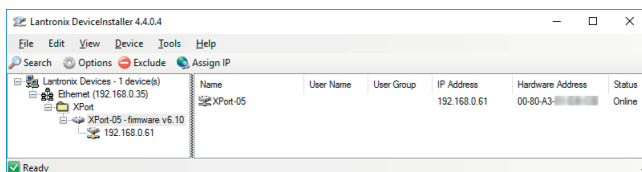

4. Select the one matched with the hardware (MAC) address and confirm the IP address. Hardware (MAC) address is written on the backside of label of the converter.

## 5-6. Assign IP address

1. Click on IP assignment.
2. Select the method and then click [Next].

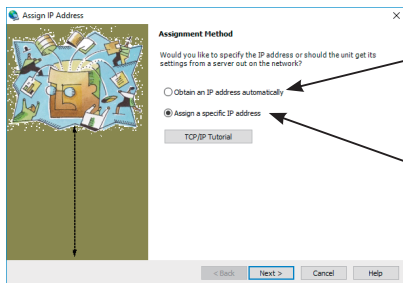

To validate the DHCP client and AutoIP address function.

To set fixed IP address.

When selecting  
[ Assign a specific IP address ]

3. Input the IP address in the [IP Settings]. Then click [Next].

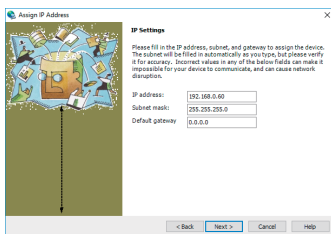

- \* Consult with your network manager.
- \* Recommend not invalidating the [Auto-IP] function.

When selecting  
[ Obtain an IP address automatically ]

3. Select the function to validate in the [IP discover setting] and then click [Next].

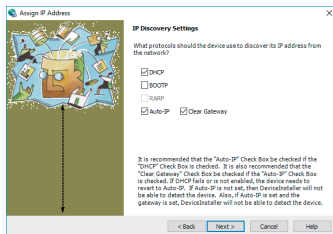

4. Click [Assign] to validate the configuration.

**Note**

Do not turn off the power of converter until completing the restart after clicking [Assign]. Writing the wrong configuration on the LAN device of Lantronix can cause a malfunction.

\*Refer to the online help of DeviceInstaller for appropriate use of DeviceInstaller.

IP address can be set using the set-up mode.

- ➔ Refer to [Xport User Guide (XPort\_UG.pdf)] and [WiPort NR User Guide (WiPort-NR\_UG.pdf)] in the CD-ROM.

IP address can be set using the configuration tool "SILANIOinit".

- ➔ Refer to [SILANIOinit.txt (instruction)] in the CD-ROM.

# Chapter 6 Configuration Using Web Manager

## 6-1. Web Manager Usage

The configuration can be changed from a Web manager.

➔ For more details refer to [ XPort User Guide (XPort\_UG.pdf) ] and [ WiPort NR User Guide (WiPort-NR\_UG.pdf) ] in the CD-ROM.

### ● Accessing from the deviceinstaller

Select the device being set. Select [Web Configuration] tab and click  icon. Enter the user name and the password, as you will be required. If you have not set your user name and password, enter nothing and click [OK].

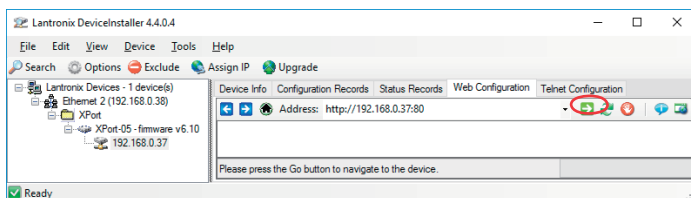

### ● Accessing from the web browser

Open your web browser and enter the IP address. Then you will be required to enter the user name and the password. If you have not set your user name and password, enter nothing and click [OK].

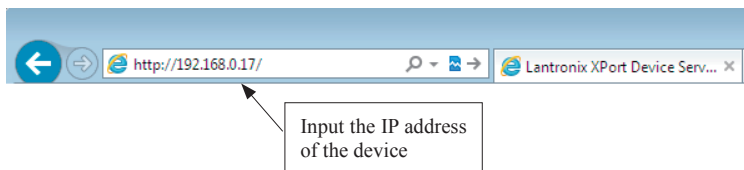

### Note

If you cannot change the setting, for Internet Explorer, please check the “Every time I visit the webpage” at “[ Tools ] - [ Internet options ] - [ General ] - [ Browsing history ] - [ Settings ] - [ Temporary Internet Files ] - [ Check for newer versions of stored pages: ]”. If it does not display correctly, please validate “Compatibility View”.

## ● Web Manager Usage

### SI-60F/SI-60

Server setting such as CPU Performance

Serial Communication Conditions setting

LAN Connection setting.\*1

Product Information	
Firmware Version:	V6.10.0.1
Build Date:	23-Oct-2014

Network Settings	
MAC Address:	00-80-A3-...
Network Mode:	Wired
DHCP HostName:	< None >
IP Address:	192.168.0.37
Default Gateway:	192.168.0.1
DNS Server:	192.168.0.1
MTU:	1400

Line settings	
Line 1:	RS232, 115200, 8, None, 1, None.

WebManager Version: 2.0.0.6 Copyright © Lantronik, Inc. 2007-2014. All rights reserved.

\*1: For SI-60P and SI-60FP, use only “Serial Settings” and “Connection(1)” of Channel 1 and do not use Channel2 and Connection(2).

### SI-60X

Server setting such as CPU Performance

Serial Communication1 Conditions setting

LAN Connection setting.

Serial Communication2 Conditions setting

LAN Connection setting.

Product Information	
Firmware Version:	V5.9.0.4
Build Date:	28-Jun-2013

Network Settings	
MAC Address:	00-20-4A-...
Network Mode:	Wired
DHCP HostName:	< None >
IP Address:	192.168.0.10
Default Gate:	192.168.0.1
DNS Server:	192.168.0.1
MTU:	1400

Line settings	
Line 1:	RS232, 9600, 8, None, 1, None.
Line 2:	RS232, 9600, 8, None, 1, None.

WebManager Version: 2.0.0.4 Copyright © Lantronik, Inc. 2007-2013. All rights reserved.

After setting the various settings such as [Port Settings], [Connection] etc., click "OK" button. Then "Done!" will be displayed and the setup contents hold by Web Manager temporarily.

To save and apply the configuration changes to the device server, click the Apply Settings button. (the Apply Settings button makes the changes permanent and reboots the XPort.)

- \* If you change the IP address on the Webmanager and set it by [Apply Setting], state of progress of configuration process will appear repeatedly, because the connection between this device and the PC for configuration cannot be sustained. In this case, please close the Web manager. Then run the Web manager again with the changed IP address.

## 6-2. Communication conditions of serial port

---

1. When using SI-60F/SI-60FP/SI-60P/SI-60X with baud rate 460800 or above, select "Server" and set High to "CPU Performance Mode". If baud rate is less than 460800, do not need to set it.
2. Select [Channel1 ] -> [Serial Settings].  
Set "Protocol" to be "RS-232C" in serial side. Set Baud Rate, Data Bits, Parity, Stop Bits and Flow Control to be same as the target device.
3. Click [ OK ] and then click [ Apply Settings ].

For SI-60X, set for "channel2" of RS-232C Port2 as well.

## 6-3. Set up LAN connection mode

---

### ■ LAN protocol

Select [ Channel 1 ] --> [ Connection ]. Then select TCP or UDP.  
You can setup either one of them.

\* IF you select UDP protocol, set [ Datagram Type ] to [ 01 ].  
Change [ Remote Host ] and [ Remote Port ] if necessary.

### ■ Server Mode

If you select TCP protocol set [ Accept Incoming ].  
Select Yes to accept incoming connections. (Server mode)

### ■ Client Mode

If you select TCP protocol set [ Active Connect ].  
Set client mode to send a request of TCP connection to other device.  
For SI-60X, set for "channel2" of RS-232C Port2 as well.

For SI-60X, set for "channel2" of RS-232C Port2 as well.

## 6-4. Other Setting

---

You can set various settings according to your usage.

- ➔ For more details refer to [ XPort User Guide (XPort\_UG.pdf) ], [ xPico User Guide (xPico\_UG.pdf) ], or [ WiPort NR User Guide (WiPort-NR\_UG.pdf) ] in the CD-ROM.

### ■ Pack Control

The packing algorithms define how and when packets are sent to the network.

Select [ Channel 1 ] --> [ Serial Settings ] and check [ Pack Control ] --> [ Enable Packing ] to control the received data as you define.

e.g.)

Packets are sent to the network, when no serial data is received for 12 msec or received 2bytes of CRC data after received 0x03

Idle Gap Time	: 12msec	
Match 2 Byte Sequence	: No	
Match Bytes	: 0x03,0x00	* For SI-60X, you can set for [Channel2] as well.
Send Frame Immediate	: No	
Send Trailing Bytes	: Two	

If the packet size reaches to the Maximum Transmission Unit(MTU)(default 1400 bytes), a transmission might occur even if the packets are not satisfy the condition.

### ■ Disconnect TCP

Select [ Channel 1 ] --> [ Connection ] and set [ Disconnect Mode ] to setup the condition of disconnect TCP by the serial non-communication time.

e.g.)

Disconnect TCP when more than 30 sec of non-communication time.

On Mdm_Ctrl_InDrop	: No	
Check EOT(Ctrl-D)	: No	* For SI-60X, you can set for [Channel2] as well.
Hard Disconnect	: Yes	
Inactivity Timeout	: 0:30(mins:secs)	

### ■ TCP Keepalive

Select [ Server ].Set [ TCP Keepalive (secs) ] 1 to 65(sec).

No TCP keepalive packet will be send, if you set 0.

Check the connection status by sending the TCP packet for checking.

### ■ Restore default XPort/WiPortNR settings

Select [ Apply Defaults ] of Main menu to initial (factory default) all setup, except network address(such as IP address etc.) and I/O pin.

- ➔ [9-2. Factory Setting]



# Chapter 7 Setup Example

## 7-1. Server mode usage

To use Device A (connected with the serial port of converter) through network connection by TCP connection request from a device on the network such as PC to the converter, please refer following setting.

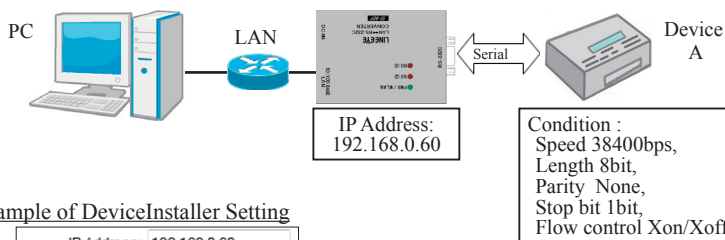

### Example of DeviceInstaller Setting

IP Address:	192.168.0.60
Subnet Mask:	255.255.255.0
Default Gateway:	0.0.0.0

\* Assign by the proper method, concerning the usage and environments, and consulting with your network manager.

### Example of Web Manager Setting

#### Serial port communication condition

Port Settings			
Protocol:	RS232	Flow Control:	Xon/Xoff
Baud Rate:	38400	Parity:	None
Data Bits:	8	Stop Bits:	1

#### Connect Mode (Server mode: Yes, Client Mode: None)

Connect Mode	
Passive Connection:	Active Connection:
Accept Incoming: Yes	Active Connect: None

## 7-2. Client Mode Usage

To use the serial port of the Device A through network connection by TCP connection request from the converter to a server on the network when the converter has received a serial data of Device A, please refer following setting.

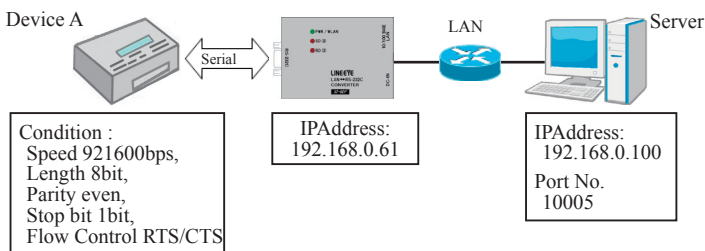

### Example of DeviceInstaller Setting

IP Address:	192.168.0.61
Subnet Mask:	255.255.255.0
Default Gateway:	0.0.0.0

\* Assign by the proper method, concerning the usage and environments, and consulting with your network manager.

### Example of Web Manager Setting

#### SerialPort Condition

**Advanced**

ARP Cache Timeout (secs): 600

TCP Keepalive (secs): 45

Monitor Mode @ Bootup:  Enable  Disable

CPU Performance Mode:  Low  Regular  High

If Speed is 460800bps or 921600bps. Select High

**Port Settings**

Protocol: RS232 Flow Control: CTS/RTS (Hardware)

Baud Rate: 921600 Data Bits: 8 Parity: Even Stop Bits: 1

#### LAN Connection Mode (Server Mode:Disable, ClientMode:Enable)

**Connect Mode**

Passive Connection: Accept Incoming: No

Active Connection: Active Connect: With Any Character

---

**Endpoint Configuration:**

Local Port: 10001 Remote HostPort No. Remote Host IP Address

Remote Port: 10005  Auto increment for active connect Remote Host: 192.168.0.100

## 7-3. Using two units of converter

To extend serial communication between Device A and Device B through network by using two units of converters, please refer following setting.

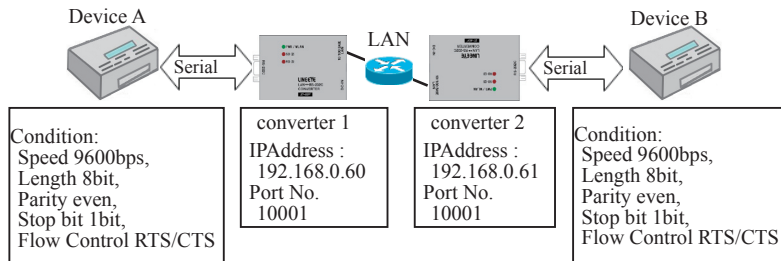

### Example of DeviceInstaller Setting

#### Converter 1

IP Address:	192.168.0.60
Subnet Mask:	255.255.255.0
Default Gateway:	0.0.0.0

#### Converter 2

IP Address:	192.168.0.61
Subnet Mask:	255.255.255.0
Default Gateway:	0.0.0.0

\* Assign by the proper method, concerning the usage and environments, and consulting with your network manager.

### Example of Web Manager Setting

#### SerialPort Condition

#### Converter 1 and 2 (9600bps)

<b>Port Settings</b>	
Protocol: RS232	Flow Control: CTS/RTS (Hardware)
Baud Rate: 9600	Parity: Even
Data Bits: 8	Stop Bits: 1

## LANConnection Mode

Converter 1 (Server Mode: Enable, ClientMode: Enable)

Connect Mode	
<b>Passive Connection:</b> Accept Incoming: Yes	<b>Active Connection:</b> Active Connect: Auto Start
<b>Endpoint Configuration:</b> Local Port: 10001	Remote Host2 Port No: 10001
<input type="checkbox"/> Auto increment Local Port for active connect	Remote Host2 IPAddress: 192.168.0.61

Converter 2 (Server Mode: Enable, ClientMode: Disable)

Connect Mode	
<b>Passive Connection:</b> Accept Incoming: Yes	<b>Active Connection:</b> Active Connect: None

After turning on the power, the converter 1 in which Active Connect is set to Auto Start connect with the converter 2 by TCP and starts data transmission via network.

## LANConnection Mode

Converter 1 (Server Mode: Enable, ClientMode:Enable)

Connect Mode	
<b>Passive Connection:</b> Accept Incoming: Yes	<b>Active Connection:</b> Active Connect: With Any Character
<b>Endpoint Configuration:</b> Local Port: 10001	Remote Host2 Port No.: 10001
<input type="checkbox"/> Auto increment Local Port for active connect	Remote Host2 IPAddress: 192.168.0.61

Converter 2 (Server Mode: Enable, ClientMode:Enable)

Connect Mode	
<b>Passive Connection:</b> Accept Incoming: Yes	<b>Active Connection:</b> Active Connect: With Any Character
<b>Endpoint Configuration:</b> Local Port: 10001	Remote Host1 Port No.: 10001
<input type="checkbox"/> Auto increment Local Port for active connect	Remote Host1 IPAddress: 192.168.0.60

Because "Active Connect" of both Converter 1 and Converter 2 are configured as "With Any Character", when a serial port of Converter 1 or 2 receives data, the device which received the data will connect with the other device by TCP and send the data through the network.

# Chapter 8 COM Port Redirector

---

## 8-1. About Virtual COM Port

---

The COM Port Redirector by Lantronics is the utility software to get the serial communication application not supporting the network connection to be able to use on the network. The redirector creates the virtual COM ports in Windows. Communications for these virtual COM ports are transferred to the serial port on the converter through the network.

### Note

- The COM Port Redirector works at most of the application software. However, some applications, which have a limit to receive/transmit data, may not work well. In this case, change the timeout of communication longer or change the setting to support socket communications.
- Supported OS of Com Port Redirector (CPR) Ver4.3.x.x are up to Windows 7/8 and Server 2008 as Lantronix informs. It may work on Windows 10 but please note that there is no guarantee by the manufacture.
- The COM Port Redirector cannot be used with other software, which creates the virtual COM port. Be sure not to install the COM Port Redirector to PCs, which have already installed such software.

## 8-2. Basic Setting

---

Depending on the target devices, setup of the serial port and virtual COM port condition is required to change.

➔ [ 6-2. Communication conditions of serial port ]

Assign a specific IP Address. (recomendation)

➔ [ Chapter 5 Basic Configuring Tasks ]

## 8-3. Install COM Port Redirector

---

Install ComPortRedirector (CPR) to your PC.

\* If you already have previous version of COM Port Redirector, please uninstall it.

Login to the PC as administrator.

1. Execute the setup file [Ver4.3.x.x] in the ComPortRedirector. Select the folder which matches your version.
2. To install, follow the installation wizard instructions.
3. Restart the PC.

NOTE Environment for the usage of supported OS differs depending on the version of the ComPortRedirector attached to the product. For further detail, please refer Release.txt in the folder of the name of the version (\lantronix\ComPortRedirector) in the CD-ROM.

## 8-4. COM Port Redirector

Connect the converter to the network.

Login to the PC as administrator.

1. From start menu, go to "Lantronix" -> "CPR 4.x" -> "CPR Manager. "CPR Manager" window will be displayed.

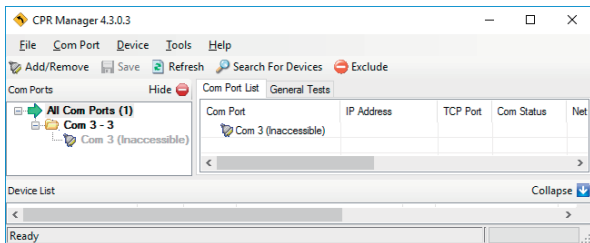

2. Click [Com Port]-[Add and Remove] of toolbar to open the dialog to register/delete the virtual COM port. Select the COM number and click [OK]. For SI-60X, select 2 COM ports
  3. In the dialog box, check the COM port you wish to use as the virtual COM port.
  4. In the [ Settings ] tab, there is a host list table. Set the IP address and port number at [ Host ] and [ TCP Port ] in the [ Service1 ]. Click [ Search For Devices ] icon and double clicking the device name such as XPort or WiPortNR on the "Device list" to reflect it in the host list table.
  5. Click "Save" icon or go to [Com Port] -> [Save Settings] to save the configurations. If your computer shows a dialog of hardware installation, ignore it and click [Next].
- ➔ For more details refer to [ Com-Port-Redirector\_QS.pdf ] in the CD-ROM.

## Chapter 9 Documents

---

### 9-1. Built in XPort

---

XPort is built in the converter and it is the LAN communication module of Lantronix. The XPort has been updated several times. Refer to the following table for XPort version and shipping date. Confirm the firmware version in the property of device, which is searched and shown by DeviceInstaller.

Shipment	Hardware	MAC address (vender code)	Firmware	WEB Manager	CPR
Since 2005	XPort-03	00-20-4A	1.8	3.6	
Since 2006	XPort-03		6.1.0.0	1.3.0.0	3.1.0.1
Since 2008	XPort-03		6.5.0.7	1.6.0.2	4.1.0.2
Since 2009	XPort-03		6.6.0.2	1.7.0.1	4.2.0.0
Since 2010	XPort-04		6.7.0.1	1.8.0.1	4.3.0.0
Since 2013	XPort-04		6.8.0.2	1.9.0.1	4.3.0.1
Since 2013	XPort-05	00-80-A3	6.9.0.2	2.0.0.2	4.3.0.3
Since 2015			6.10.0.1	2.0.0.6	

- \* To use this product properly, please use the manual and the tools contained in the CD-ROM, which comes with the product.
- \* XPort-05 firmware is not compatible with the firmware of XPort-03/04
- \* For more details, refer to the web sight of Lantronix (<http://www.lantronix.com>)

### 9-2. Factory setting

---

#### RS-232C Condition

Protocol: RS-232 (Do not change)

Speed: 9600bps, 8bit, Parity: None, Stop 1bit, Flow Control: None

#### LAN Action Mode

Accept Incoming: Yes (Server Mode: Enable)

Active Connect: None (Client Mode: Disable)

Local port of Channel 1: 10001

Local port of Channel 2: 10002 (SI-60X only)

IP Address 0.0.0.0 (DHCP Client Function and AutoIP Function: Enable)

Telnet password:

(Password: Disable)

Configuration pins (general purpose IO pin) → [Chapter 1.2]

• SI-60F/SI-60

Pin	Definition	Active Level
CP1	HW Flow Control Out	Low
CP2	General Purpose I/O Input	Low
CP3	HW Flow Control In	Low

\*Do not change the setting of CP2 and Active Level.

• SI-60FP/SI-60P(xPico)

Pin	Definition	Active Level
CP1 ~ CP8	General Purpose I/O Input	Low

• SI-60X

Pin	Definition	Active Level
CP3	Modem Ctrl Channel 1 Out	Low
CP4	Modem Ctrl Channel 1 In	Low
CP5	Modem Ctrl Channel 2 Out	Low
CP6	Modem Ctrl Channel 2 In	Low
CP9	Reset to Defaults (Ethernet)	Low

- \* Do not change the setting of CP9. That prohibits initializing the setting by INIT switch.
- \* CP pin will be Non-active (High) when turning on the power. Change “Active Level” to be “High” in the “General Purpose I/O Output” of CP3 and CP5 to make ER(DTR) signal active when turning on the power. → [Chapter 4-1]

Other initial settings are same on the factory default of XPort, xPico, and WiPortNR. For more details refer to [ XPort User Guide (XPort\_UG.pdf) ], [ xPico User Guide (xPico\_UG.pdf) ], or [ WiPort NR User Guide (WiPort-NR\_UG.pdf) ] in the CD-ROM.



### 9-3. How to apply the factory setting

To apply the factory setting into SI-60/SI-65/SI-65A/SI-60F/SI-60X, download the configuration file from the utility CD([ /LINEEYE/SetupRecord ]).Apply the downloaded file when selecting the setup record file.

SI-60F / SI-60F-L	SI-60X	SI-60
SI_60F_V61001.rec	SI-60X_V6904.rec	SI_60_V61001.rec
SI-60FP	SI-60P	
SI_60FP_V61001.rec	SI-60P_V61001.rec	

Use deviceInstaller or [ SILANIOinit ](configuration tool) to apply the factory settings into the converter.

\* After a password is set, it cannot be returned to the status without password.

#### Operation of [ SILANIOinit ](configuration tool)

1. Copy "SILANIOinit.exe" from the "/LINEEYE/SILANIOinit" folder in the utility CD to the appropriate folder (For example, "c:/setup/").
2. Set your device in the same network segment as your PC.
3. To execute the program, double click on "SILANIOinit" and click "search" to display all XPort/WiPortNR embedded

Select your target device.

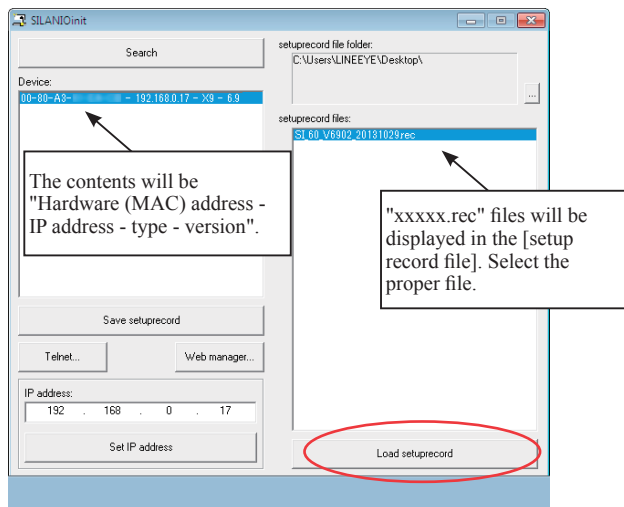

4. Click [save setup record] and the configuration will be saved.  
➔ To use this application, refer to the "SILANIOinit.txt" in the CD-ROM.

### Operation of DeviceInstaller

1. Install DeviceInstaller to your PC and download the configuration file from the utility CD to the appropriate folder (For example, "c:/setup/").  
➔ [ 5-4. Usage of DeviceInstaller ]
2. Set your device in the same network segment as your PC.(If your devices are not in the same network segment, you may not be able to set.)
3. Start Deviceinstaller and click [Search] to display all XPort/WiPortNR embedded. Select your target device.
4. Click upgrade icon or go to [Device] ➔[Upgrade].
5. [Device upgrade wizard –step 1/5] will appear. Select [Custom install] and click [Next].
6. [Device upgrade wizard –step 2/5] will appear. Click [Next].
7. [Device upgrade wizard –step 3/5] will appear. Select [Install setup records from a file] and click [Browse].
8. Open the configuration file in the appropriate folder (For example, "c:/setup/") . Click [Next].
9. [Device upgrade wizard –step 4/5] will appear. Click [Next]. Start the writing of configuration files to the target device.
10. [Device upgrade wizard –step 5/5] will appear. "installation has finished" will be displayed. Close the window.  
➔ For more details refer to DeviceInstaller User's Guide (\lantronix\Docs\DeviceInstaller\_UG.pdf )

\* The IP address cannot be returned to the default one by this method. To set an IP address, use IP allotment function of the Device Installer. → [Chapter 5-6]

#### Note

Please note that if you write inappropriate configuration file (e.g. configuration file for different models or different versions of the firmware), the LAN device of Lantronix may not run correctly and will need to be repaired.

## 9-4. General-purpose I/O pins

---

To read the input status of CP2 on the general purpos I/O pin, send TCP/IP or UDP/IP command to the port number 30704.

CP2(DR and ER of RS-232C Control line) check command of SI-60F/SI-60

Command : 13h 00h 00h 00h 00h 00h 00h 00h (9 byte)

Response : 13h xxh 00h 00h 00h (5 byte)

\* "xxh" bit 1 = 0 :DR and ER of RS-232C Control line are non active.

\* "xxh" bit 1 = 1 :DR and ER of RS-232C Control line are active.(+ 3V and above)

## 9-5. LAN Connector Specification

---

### LAN Connector Pin Assignment

Pin No.	Name	I/O Direction <sup>*1</sup>	Description
1	TX+	Out	Transmission Data +
2	TX-	Out	Transmission Data -
3	RX+	In	Reception Data +
4	-	-	Not Used
5	-	-	Not Used
6	RX-	In	Reception Data -
7	-	-	Not Used
8	-	-	Not Used

\*1 "Out" means a direction to output signals from the converter. "In" means a direction to input signals to the converter.

### LAN Connector LED Display (SI-60F/SI-60)

Left LED	Right LED	Meaning
OFF		Does not connect Ethernet.
Solid Amber		Connected 10 Base. <sup>*1</sup>
Solid Green		Connected 100 Base.
	OFF	Idle
	Blinking Amber	Communicating in the half-duplex mode. <sup>*2</sup> (Lights only when communicating.)
	Blinking Green	Communicating in the full-duplex mode. <sup>*2</sup> (Lights only when communicating.)

\*1: For SI-60X The LED lights in green when using 10BASE-T.

\*2: For SI-60FP and SI-60P the LED lights in amber when using half-duplex or full-duplex.  
For SI-60X The LED light in green.

## 9-6. Installation Method

Rubber feet are put on the bottom of the device. Please set it on a flat and stable place.

### ■ Set in the stable place

Rubber feet are put on the bottom of the device. Please set it on a flat and stable place.

### ■ Using screws

There are four M3 screw holes on the back of converter.

#### Note

Use M3 screw, which can be inserted into the converter less than 7mm depth from the top of the case. If the depth is deeper than that, it will damage the main circuit.

Screw holes on backside (same in all models)

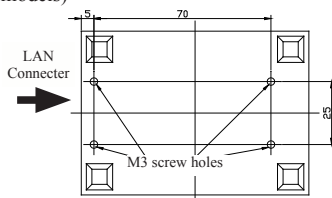

Screw holes on side (SI-60X only)

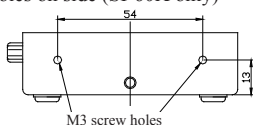

L-metal fitting (SI-ML1)

For SI-60X, it is possible to screw from the front of the device after inserting the L-metal fitting on the side.

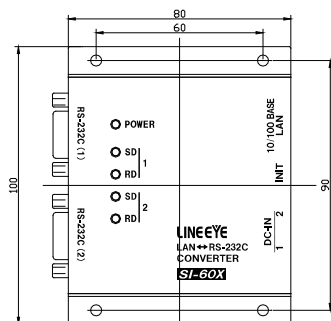

Optional L-metal (SI-ML1) fitting condition

### ■ DIN rail

Optional DIN rail mounting plate (SI-DIN70) is useful to attach the device on the DIN rail.

1. Screw DIN rail mounting plate (SI-DIN70) to M3 screw hole of the bottom of the product.
2. Insert it by pushing it into the DIN rail from the front side of the rail.
3. To remove the plate from the DIN rail, pull up the knob using the screwdriver etc.

DIN rail mounting plate (SI-DIN70)



■ Usage of Wall bracket (SI-WM1) (For SI-60/SI-60F)

With a wall bracket (SI-WM1, optional), you can fix the converter to a wall by screwing from the upper side of the bracket or hooking it to screws or nails hammered into the wall.

Wall bracket (SI-WM1)

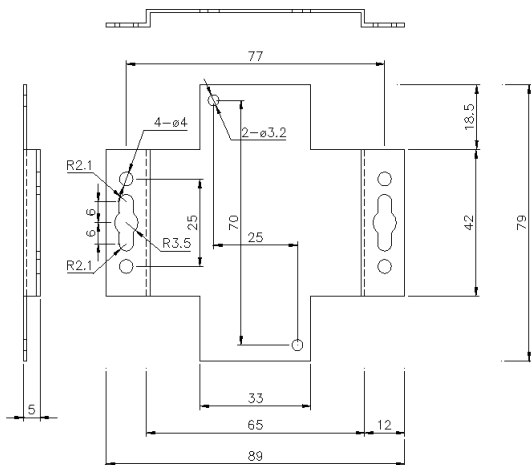

To attach to the wall (SI-60F-L)

SI-60F-L can be hung on the wall by screwing from upper side.

SI-60F-L does not support L Bracket nor DIN plate.

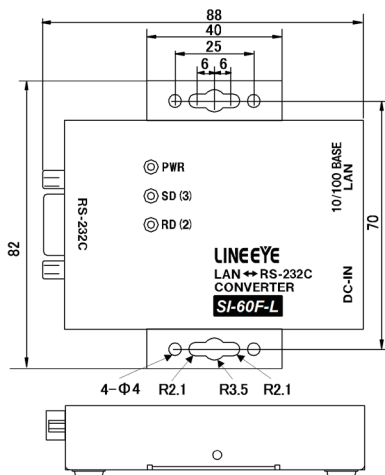

## 9-7. Ordering information

Name	Model	Description
Interface ConverterSI-60F	SI-60F	Japanese model *1
	SI-60F-L	Wall hanging model
	SI-60F-E	Overseas model *2
	SI-60F-NS	Converter and warranty only *3
Interface ConverterSI-60FP	SI-60FP	Standard Model*4
Interface ConverterSI-60	SI-60	Standard Model *1
	SI-60-E	Overseas model *2
	SI-60-NS	Converter and warranty only *3
Interface ConverterSI-60P	SI-60P	Standard Model*4
Interface ConverterSI-60X	SI-60X	Japanese model *1
	SI-60X-E	Overseas model *2
	SI-60X-NS	Converter and warranty only *3

\*1: The Japanese model is provided with utility CD, manual, warranty, and AC adapter (VFN-650B2) with an input of 100VAC.

\*2: The overseas model is provided with utility CD, manual, warranty, and AC adapter (6A-181WP09) with an input range of 100 to 240VAC. English manual is in utility CD as PDF format.

\*3: This model is for customers who purchase several units. Utility CD, manual and AC adapter are not provided. Configuration tools stored in the utility CD are available from web page.

\*4: These models are for both Japanese market and foreign markets. English manual is included in the attached CD-ROM.

## 9-8. Option

Name	Model	Remarks
Wide input AC adapter	6A-181WP09	Input AC100 to 240V, 50/60Hz
RS-232C cable	SI-RS259	DSUB 25pin (female) - DSUB 9pin (male) 1.8m
RS-232C cable	SI-RS99	DSUB 9pin (female) - DSUB 9pin (female) 1.8m
LAN cable	SI-CSEL-S3	Category 5e, 3m
AUX cable	LE2-8C	Dedicated to SI-60
Power plug cable	SIH-2PG	Mainly for SI-60F
Power branch cable	LAX-2XH	For XH connector (dedicated to SI-60x)
Power cable	LAX-15XH	For XH connector (dedicated to SI-60x)
L Bracket	SI-ML1	Dedicated to SI-60x
Wall bracket	SI-WM1	Does not support SI-60X
Magnet	SI-MG70	Two magnets to attach the unit on the steel panel
DIN plate	SI-DIN70	For installation to 35mm DIN rail.
DIN vertical plate	SI-DIN30	For installation to 35mm DIN rail vertically (for SI-60X).
DIN vertical plate	SI-DIN30S	For installation to 35mm DIN rail vertically (It does not support SI-60X.)

For more details about optional goods, please contact LINEEYE distributors or LINEEYE.

## Chapter 10 Warranty and After-Sales Service

---

### 10-1. Troubleshooting

---

The "PWR" LED does not light.

< When using the AC adapter > Is the AC adapter connected correctly?	Check that you plug the AC adapter into the AC adapter plug or wall outlet correctly. Check the voltage of AC adapter.
< When powering from the connector > Is the RS-232C connector connected correctly?	Check that you connect the RS-232C connector correctly. Check the voltage of DC power.

Neither the left and right LEDs for the LAN connector do not light or blink.

Is the LAN cable connected correctly?	Check that the connector is connected correctly, or that the cable breaks, etc.
Is the link LED on the switching hub lighting?	Try to connect with other port of hub.
Connect two units or to a PC using LAN cable?	Use the cross-over LAN cable

Cannot find in the Device installer

Is the converter connected to the same network segment with PC?	If the converter is connected to a different network segment the Device Installer cannot search it. When you mistakenly set an IP address of an other segment, use the set up mode and set the IP address.
Is IP address of the converter duplicated with other equipment ?	If the IP address of the converter duplicated with other equipment, take off the LAN cable immediately and change the IP address. ➔ For more details refer to [Xport User Guide (XPort_UG.pdf)] and [WiPort NR User Guide (WiPort-NR_UG.pdf)] in the CD-ROM.
Does the security software on the PC interrupt communications?	Check the settings in your OS or security software.
Is the network setting of the PC correct?	For a laptop which has Wi-Fi interface and wired Ethernet interface, change the networks setting to the one which the converter is connected.

Accessing from the Web browser cannot start the Web manager.

Do you correctly Assign IP Address?	Check the IP address on the converter.
Do routers, firewall or others on the network interrupt communications?	Contact your network administrator to check.

Set from the Web browser but cannot reflect when opening it again.

Check the setting of IE.	➔ Refer the Note of [6-1. Web Manager Usage]
--------------------------	--

Cannot connect the converter from the network.

Is the IP address and port number set correctly?	Search the device by using the device installer and check the network address again.
Is the converter connected to the other network segment beyond the router?	Assign IP Address of router to default gateway of the converter. Also condition of router firewall may need to be changed, contact your network administrator to check.
Are you using COMPortRedirector?	Please confirm if the COMPort No. which is set on the COMPortRedirector is used on the side of the application software.
Is the connection mode set to Server Mode?	Check the condition of converter.

Cannot communicate on the serial port side (SI-60F, SI-60, SI-60X)

Are Data Status LEDs blinking?	It is working correctly if the SD and RD LEDs are blinking on the timing of data transmission. Note: This can be difficult to distinguish when the transmitted data is too small.
Is the RS-232C cable connected correctly?	Check that the connector is connected correctly, or that the cable breaks, etc.
Is the DTE/DCE change-over switch on the SI-60/SI-60P set correctly?	Check the specifications for the RS-232C connectors and cables on the target devices, and conduct the proper setup.
Is the communication condition set correctly?	Set to the same values the communication speed, data bits, parity, stop bits, flow control, etc on both the converter and target device.
Can it communicate with a serial port of the PC?	Confirm if it can communicate with the PC in the communication condition of set-up mode by serial connection. ➔ For more details refer to [Xport User Guide (XPort_UG.pdf)] and [WiPort NR User Guide (WiPort-NR_UG.pdf)] in the CD-ROM.

The communication data line is divided when converted.

Do you use the device without setting Pack Control (Default value is NONE)?	Refer to "Pack Control" of [6-4. Other settings].
---	---



## 10-2. Warranty and Repair

---

### Warranty

Within a period of 12 months from the date of shipment, LINEEYE warrants that your purchased products (excepting consumable parts such as the batteries and software) are free of charge from any defects in material and workmanship, only when the products are operated in accordance with procedures described in the documents supplied by LINEEYE. If the defects exist during the Warranty period, please send back the products to LINEEYE distributors or LINEEYE office. LINEEYE will repair or exchange them at no charge. In this case, the shipping charge will be at your own expense.

- The foregoing warranties are the sole warranties given by LINEEYE. Above warranties shall not be applied to the products that have been modified, repaired or altered (excepting by LINEEYE employees) or that have been subjected to unusual physical or electrical stress, misuses, abuse, negligence or accidents.

LINEEYE disclaims all other warranties including the warranties of merchantability, fitness for some particular purposes and noninfringement of third party right. LINEEYE cannot promise that the software is error-free or will operate without any interruption. When you have some errors while operating the software, please refer to the contents and modified programs shown on our web page (<http://www.lineeye.com>). Please download it from there.

### Repair

LINEEYE will repair the products at your own expense.

For malfunction, please contact the LINEEYE distributors where you purchased at. Or, contact us directly.

If your product needs to be repaired, please read details about a repair on our web page and ask for a repair.

## 10-3. After-Sales Service

---

Our web site contains information about this product. In addition, LINEEYE provides a support for technical questions by Mail Form (click "contact us" on our web site).

For supports, the user registration is required. Please be sure to register from the registration page on our web site.

There is a registration page on our web site.  
( <http://www.lineeye.com> )  
Please register your product for further support. We  
will provide you the firmware update information  
and sales information etc.

# LINEEYE CO., LTD.

4F., Marufuku Bldg., 39-1, Karahasi, Nishihiragaki-cho, Minami-ku, Kyoto, 601-8468, Japan  
TEL: 075-693-0161 FAX: 075-693-0163

URL: <http://www.lineeye.com>  
Email: [info@lineeye.co.jp](mailto:info@lineeye.co.jp)

Printed in Japan

M-29860FXE/SI